

ROECO

Bearing Data

Ball Bearing Units

Bearing No. : **UCC307**

Dimensions

H = 110

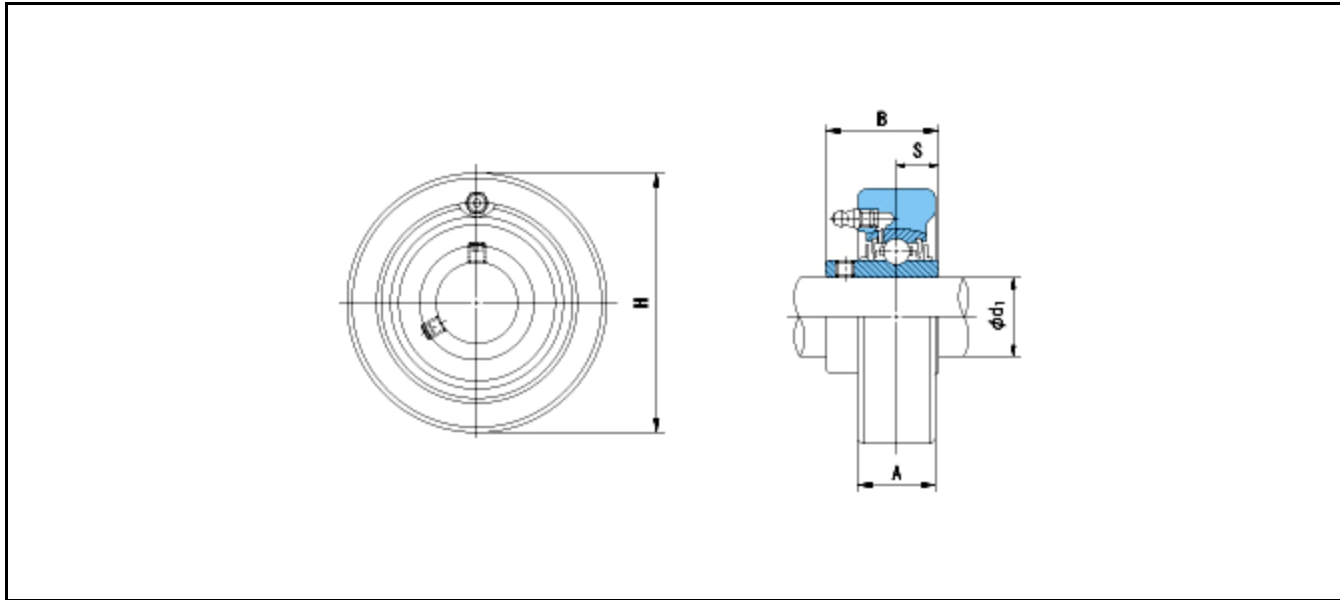

Dimensions

d1 = 35

A = 32

B = 48

S = 19

Mass = 1.8 kg

Basic Dynamic Load Rating Cr :	33500 N			
Basic Static Load Rating Cor :	19200 N	O.D.Surface Runout with Side :		-
Limiting Speed ;		Axial Runout with Bore :	-	
Grease Lubrication :	- rpm	Axial Runout with Raceway :	-	-
Oil Lubrication :	- rpm	Width Variation :	-	-
		Radial Runout :	-	-