

ROECO

Bearing Data

Ball Bearing Units

Bearing No. : **UCC313**

Dimensions

H = 170

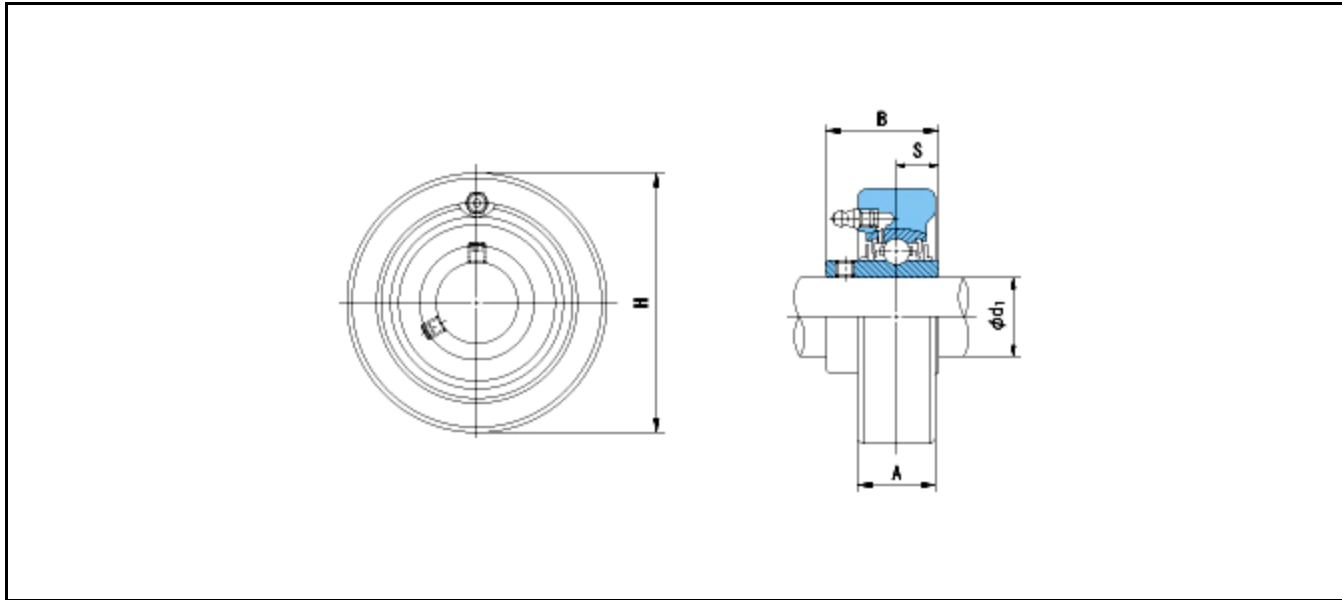

Dimensions

d1 = 65

A = 50

B = 75

S = 30

Mass = 5.7 kg

Basic Dynamic Load Rating Cr :	92500 N				
Basic Static Load Rating Cor :	59700 N	O.D.Surface Runout with Side :			-
Limiting Speed ;		Axial Runout with Bore :			-
Grease Lubrication :	- rpm	Axial Runout with Raceway :			-
Oil Lubrication :	- rpm	Width Variation :			-
		Radial Runout :			-