

ROECO

Bearing Data

Ball Bearing Units

Bearing No. : **UCF207C**

Dimensions

L = 117

J = 92

N = 14

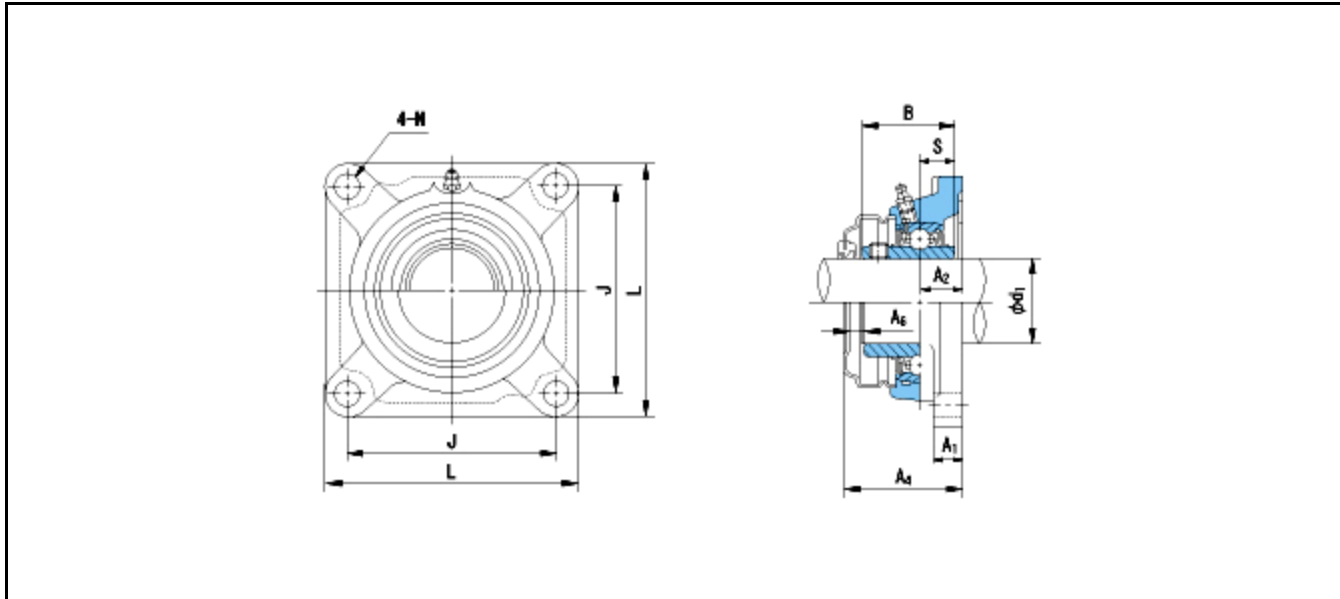

Dimensions

d1 = 35

A1 = 16

A2 = 19

B = 42.9

S = 17.5

A4 = 54

A6 = 8

Mass = 1.6 kg

Basic Dynamic Load Rating Cr :	25900 N			
Basic Static Load Rating Cor :	15400 N	O.D.Surface Runout with Side :		-
Limiting Speed ;		Axial Runout with Bore :		-
Grease Lubrication :	- rpm	Axial Runout with Raceway :		-
Oil Lubrication :	- rpm	Width Variation :		-
		Radial Runout :		-