

ROECO

Bearing Data

Ball Bearing Units

Bearing No. : **UCF215**

Dimensions

L = 200

J = 159

N = 19

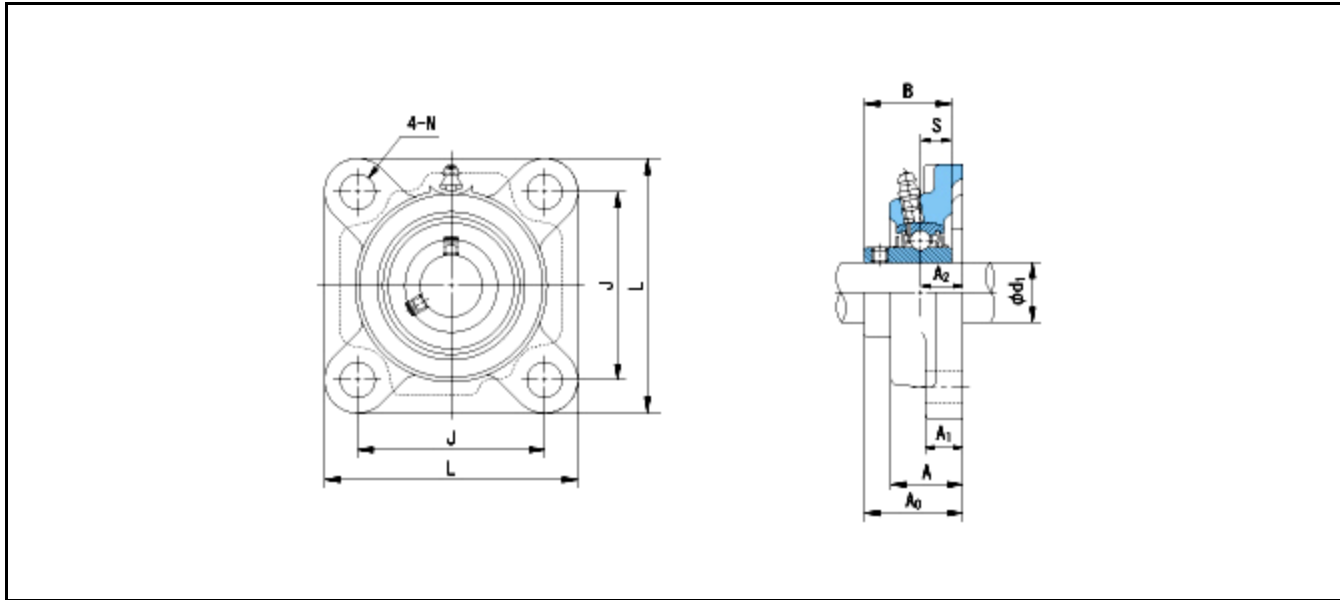

Dimensions

d1 = 75

A1 = 24

A2 = 34

B = 77.8

S = 33.3

A = 56

A0 = 78.5

Mass = 6.9 kg

Basic Dynamic Load Rating Cr :	66000 N				
Basic Static Load Rating Cor :	48200 N	O.D.Surface Runout with Side :			-
Limiting Speed ;		Axial Runout with Bore :			-
Grease Lubrication :	- rpm	Axial Runout with Raceway :			-
Oil Lubrication :	- rpm	Width Variation :			-
		Radial Runout :			-