

ROECO

Bearing Data

Ball Bearing Units

Bearing No. : **UCFC212**

Dimensions

L = 195

J = 160

N = 19

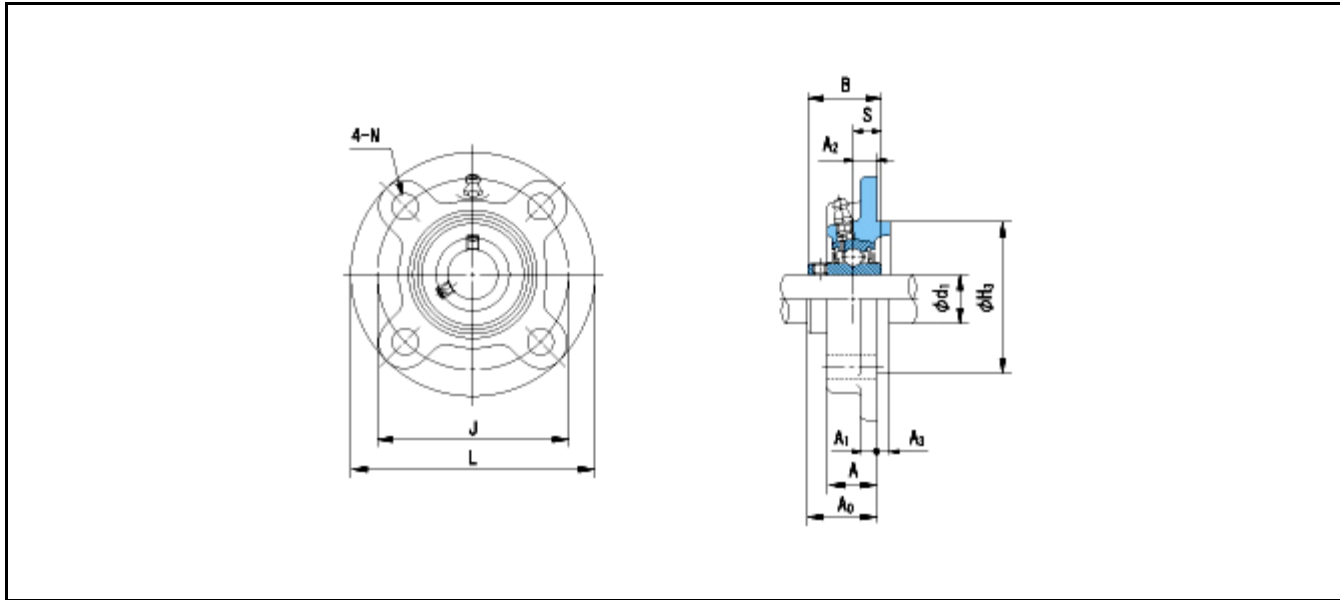

Dimensions

d1 = 60

A = 36

A1 = 15

A2 = 17

A3 = 12

H3 = 135

B = 65.1

S = 25.4

A0 = 56.7

Mass = 4.4 kg

Basic Dynamic Load Rating Cr : **52500 N**

Basic Static Load Rating Cor : **36100 N**

Limiting Speed ;

Grease Lubrication : - rpm

Oil Lubrication : - rpm

INNER RING OUTER RING

O.D.Surface Runout with Side : -

Axial Runout with Bore : -

Axial Runout with Raceway : -

Width Variation : -

Radial Runout : -