

ROECO

Bearing Data

Ball Bearing Units

Bearing No. : **UCFS310**

Dimensions

L = 175

J = 132

N = 23

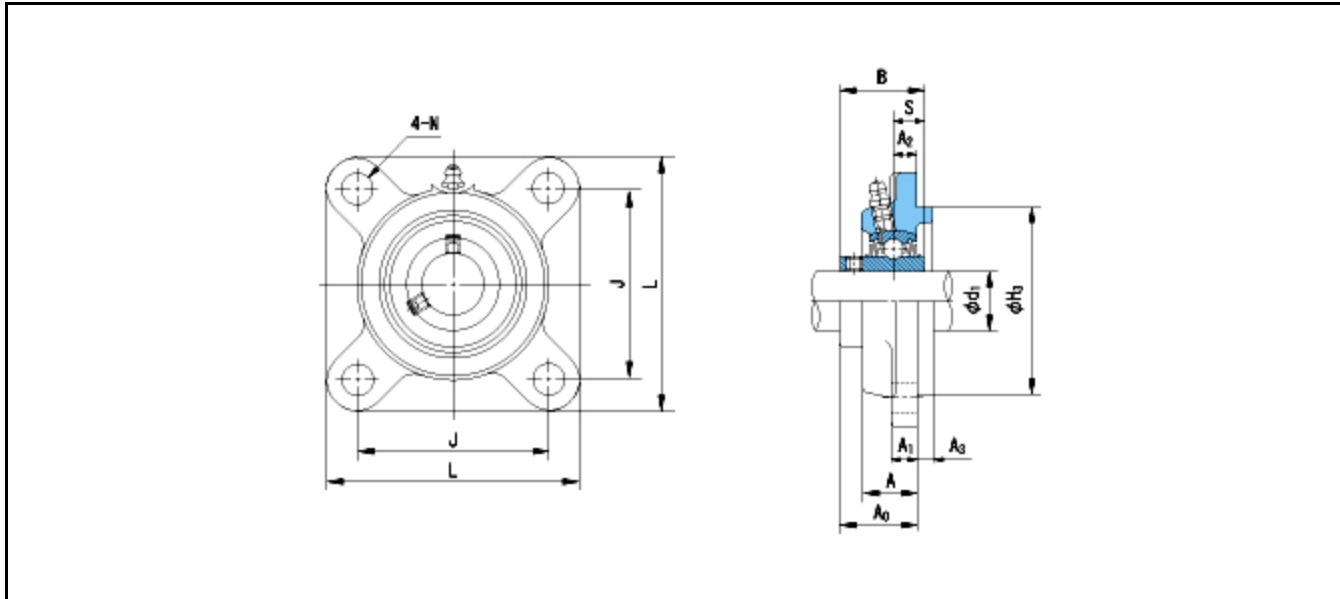

Dimensions

d1 = 50

A1 = 19

A2 = 16

H3 = 140

B = 61

S = 22

A = 36

A0 = 55

Mass = 5.3 kg

Basic Dynamic Load Rating Cr :	61500 N		
Basic Static Load Rating Cor :	38200 N	O.D.Surface Runout with Side :	-
Limiting Speed ;		Axial Runout with Bore :	-
Grease Lubrication :	- rpm	Axial Runout with Raceway :	-
Oil Lubrication :	- rpm	Width Variation :	-
		Radial Runout :	-