

ROECO

Bearing Data

Ball Bearing Units

Bearing No. : **UCFS322**

Dimensions

L = 340

J = 266

N = 41

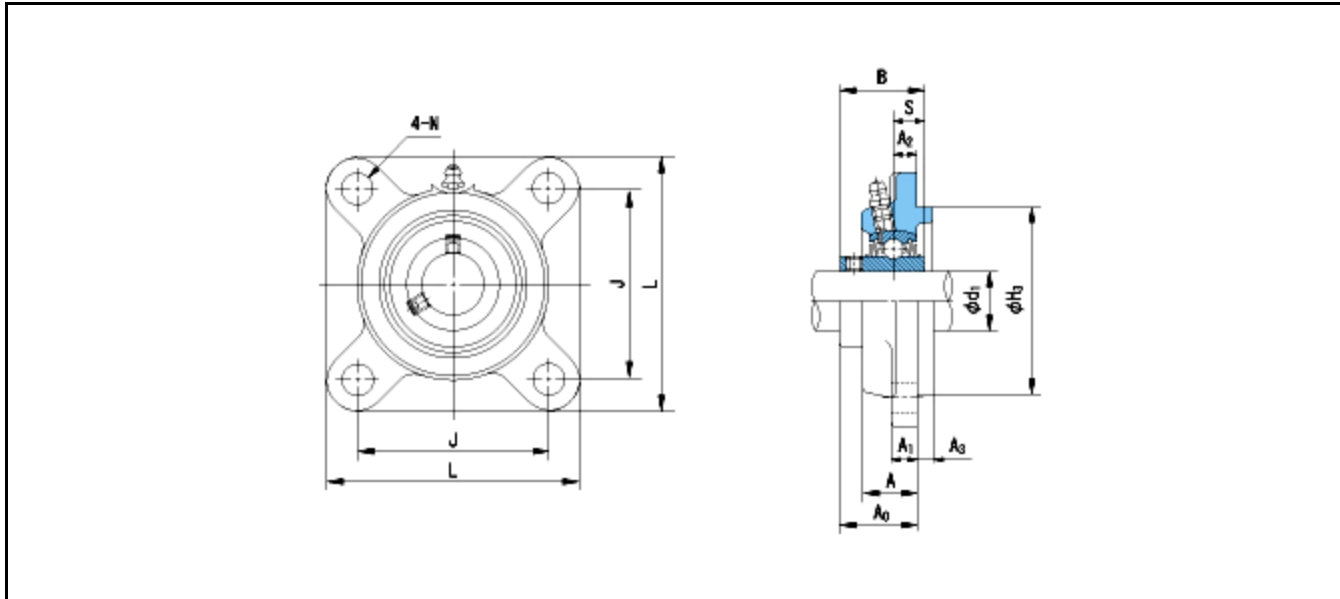

Dimensions

d1 = 110

A1 = 35

A2 = 35

H3 = 300

B = 117

S = 46

A = 71

A0 = 106

Mass = 36.8 kg

Basic Dynamic Load Rating Cr :	205000 N		
Basic Static Load Rating Cor :	178800 N	O.D.Surface Runout with Side :	-
Limiting Speed ;		Axial Runout with Bore :	-
Grease Lubrication :	- rpm	Axial Runout with Raceway :	-
Oil Lubrication :	- rpm	Width Variation :	-
		Radial Runout :	-