

ROECO

Bearing Data

Ball Bearing Units

Bearing No. : **UCFX10E**

Dimensions

L = 162

J = 130

N = 19

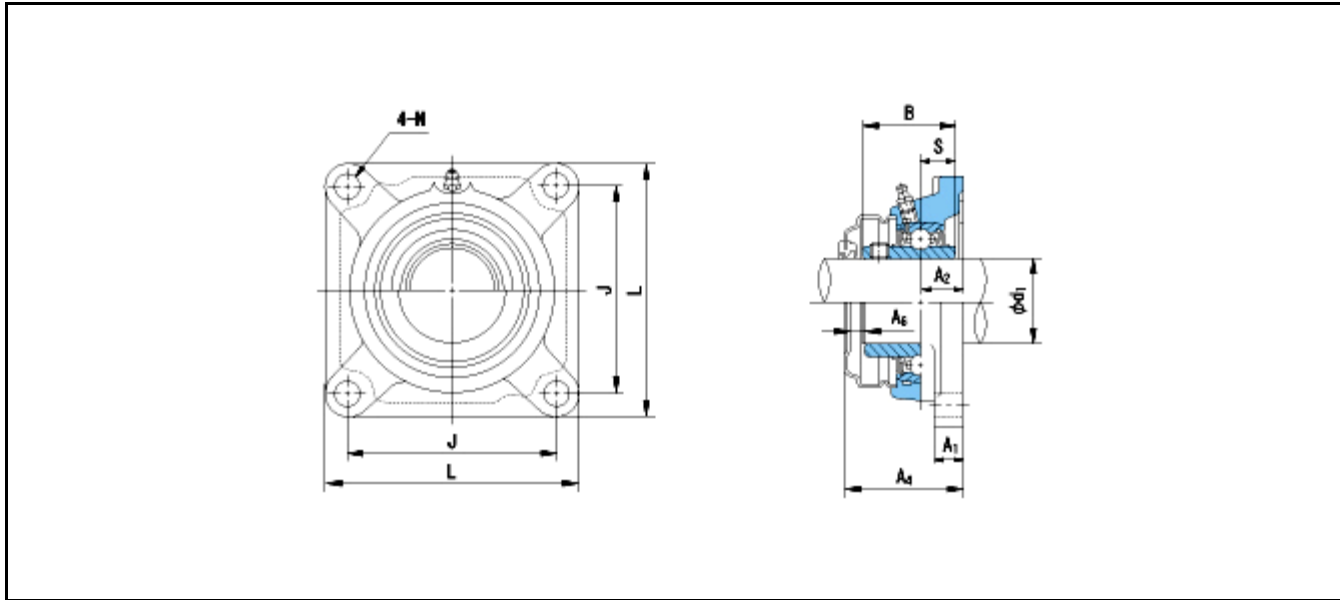

Dimensions

d1 = 50

A1 = 20

A2 = 26

B = 55.6

S = 22.2

A4 = 70

A6 = 9

Mass = 3.7 kg

Basic Dynamic Load Rating Cr :	43000 N				
Basic Static Load Rating Cor :	29400 N	O.D.Surface Runout with Side :			-
Limiting Speed ;		Axial Runout with Bore :			-
Grease Lubrication :	- rpm	Axial Runout with Raceway :			-
Oil Lubrication :	- rpm	Width Variation :			-
		Radial Runout :			-