

ROECO

Bearing Data

Ball Bearing Units

Bearing No. : **UCP319**

Dimensions

H = 125

L = 470

J = 360

N1 = 50

H1 = 50

H2 = 250

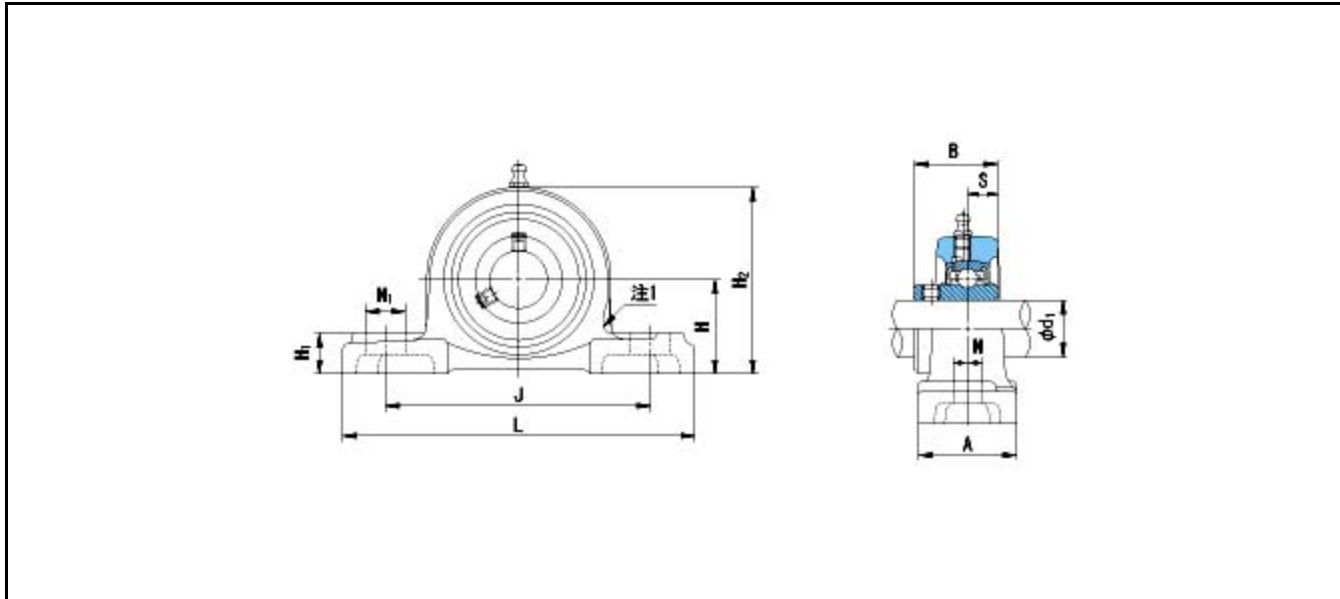

Dimensions

d1 = 95

A = 120

N = 36

B = 103

S = 41

Mass = 26.5 kg

Basic Dynamic Load Rating Cr :	153000 N		
Basic Static Load Rating Cor :	118400 N	O.D.Surface Runout with Side :	-
Limiting Speed ;		Axial Runout with Bore :	-
Grease Lubrication :	- rpm	Axial Runout with Raceway :	-
Oil Lubrication :	- rpm	Width Variation :	-
		Radial Runout :	-