

ROECO

# Bearing Data

## Ball Bearing Units

Bearing No. : **UKFC207+H2307**

Dimensions

L = 135

J = 110

N = 14

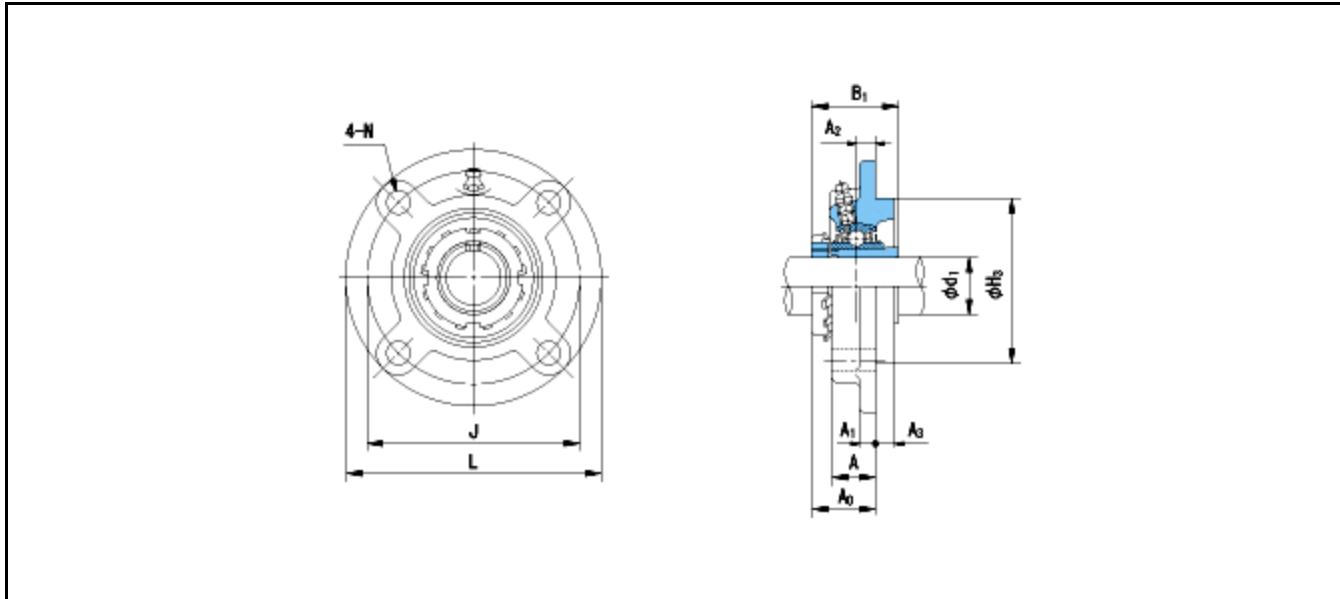

Dimensions

d1 = 30

A = 26

A1 = 9

A2 = 11

A3 = 8

H3 = 90

B1 = 43

A0 = 33.5

Mass = 1.8 kg

Basic Dynamic Load Rating Cr :	<b>25900 N</b>				
Basic Static Load Rating Cor :	<b>15400 N</b>	O.D.Surface Runout with Side :			-
Limiting Speed ;		Axial Runout with Bore :			-
Grease Lubrication :	- rpm	Axial Runout with Raceway :			-
Oil Lubrication :	- rpm	Width Variation :			-
		Radial Runout :			-