

ROECO

Bearing Data

Ball Bearing Units

Bearing No. : **UKFL207E+H2307**

Dimensions

H = 161

L = 90

J = 130

N = 16

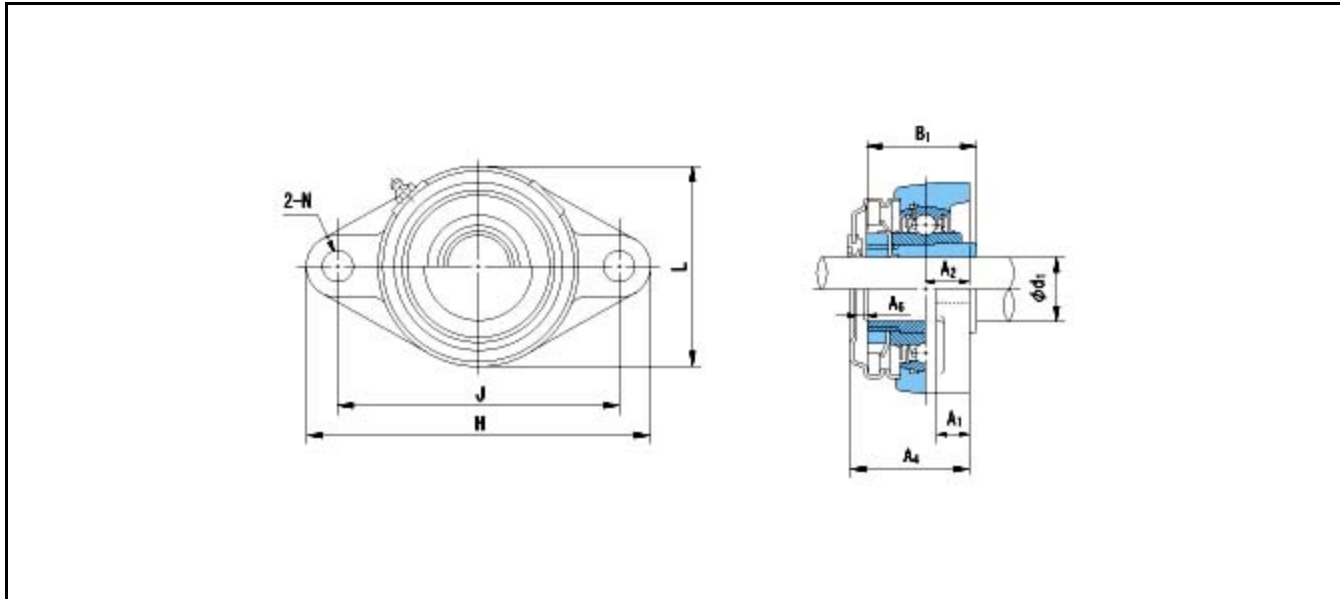

Dimensions

d1 = 30

A1 = 16

A2 = 19

A4 = 54

A6 = 11

B1 = 43

Mass = 1.4 kg

Basic Dynamic Load Rating Cr :	25900 N		INNER RING	OUTER RING
Basic Static Load Rating Cor :	15400 N	O.D.Surface Runout with Side :		-
Limiting Speed ;		Axial Runout with Bore :	-	-
Grease Lubrication :	- rpm	Axial Runout with Raceway :	-	-
Oil Lubrication :	- rpm	Width Variation :	-	-
		Radial Runout :	-	-