

ROECO

Bearing Data

Ball Bearing Units

Bearing No. : **UKP206+H2306**

Dimensions

H = 42.9

L = 165

J = 121

N1 = 21

H1 = 18

H2 = 83

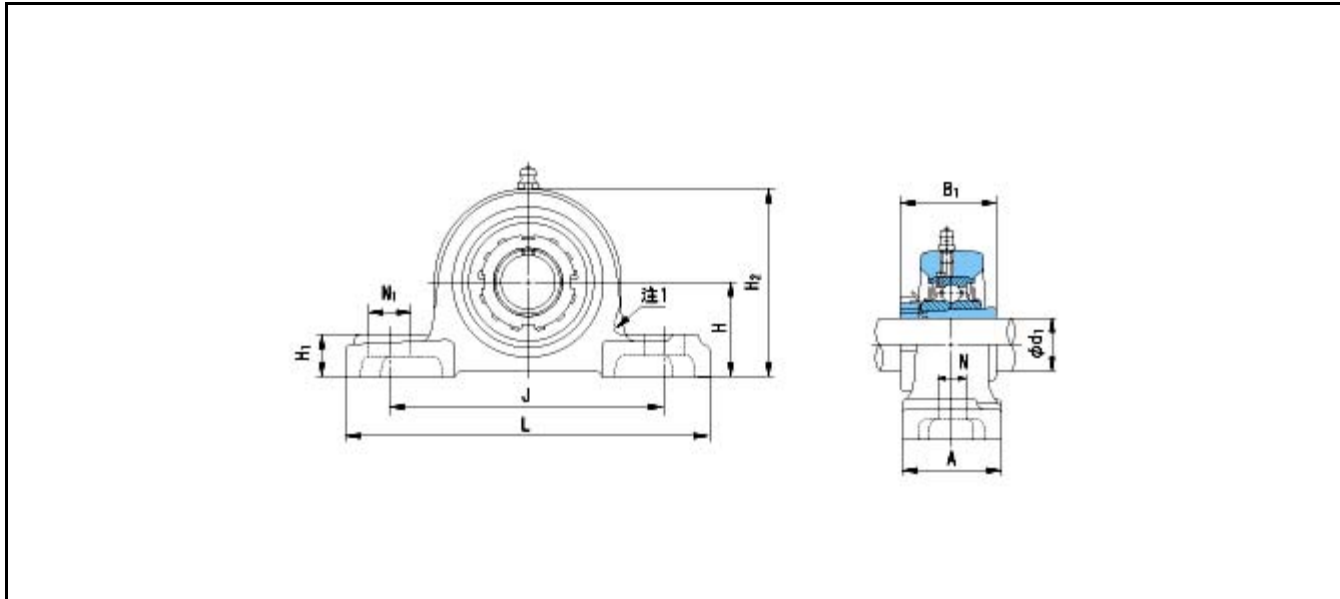

Dimensions

d1 = 25

A = 48

N = 17

B1 = 38

Mass = 1.4 kg

Basic Dynamic Load Rating Cr :	19600 N	INNER RING	OUTER RING
Basic Static Load Rating Cor :	11300 N	O.D.Surface Runout with Side :	-
Limiting Speed ;		Axial Runout with Bore :	-
Grease Lubrication :	- rpm	Axial Runout with Raceway :	-
Oil Lubrication :	- rpm	Width Variation :	-
		Radial Runout :	-